



P24C512B-D8H

I²C-Compatible Serial E²PROM

Data Sheet Rev. 1.0

General Description

The P24C512B is a 512-Kbit I²C-compatible Serial EEPROM (Electrically Erasable Programmable Memory) device. It contains a memory array of 64 K × 8 bits, which is organized in 128-byte per page. P24C512B provides the following devices for different application.

Device Selection Table

Device Name	Voltage Range	Temp. Range	Max. Clock Frequency
P24C512B -D8H	1.7V~5.5V	-40°C ~ 85°C	1MHz

Features

- Single Supply Voltage and High Speed
 - ◇ Minimum operating voltage down to 1.7V
 - ◇ 1 MHz clock from 1.7V to 5.5V
 - ◇ 400kHz clock from 1.7V to 2.5V
- Low power CMOS technology
 - ◇ Read current 500uA, maximum
 - ◇ Write current 2.5mA, maximum
- Schmitt Trigger, Filtered Inputs for Noise Suppression
- Sequential & Random Read Features
- 128 byte Page Write Modes, Partial Page Writes Allowed
- Write protect of the whole memory array
- Additional Write Lockable Page
- Self-timed Write Cycle (5ms maximum)
- High Reliability
 - ◇ Endurance: 4 Million Write Cycles
 - ◇ Data Retention: 200 Years
 - ◇ HBM: 6KV
 - ◇ Latch up Capability: +/- 200mA
- Package
 - ◇ 8-balls WLCSP

1. Pin Configuration

1.1 Pin Configuration

Figure 1-1 Pin Configuration

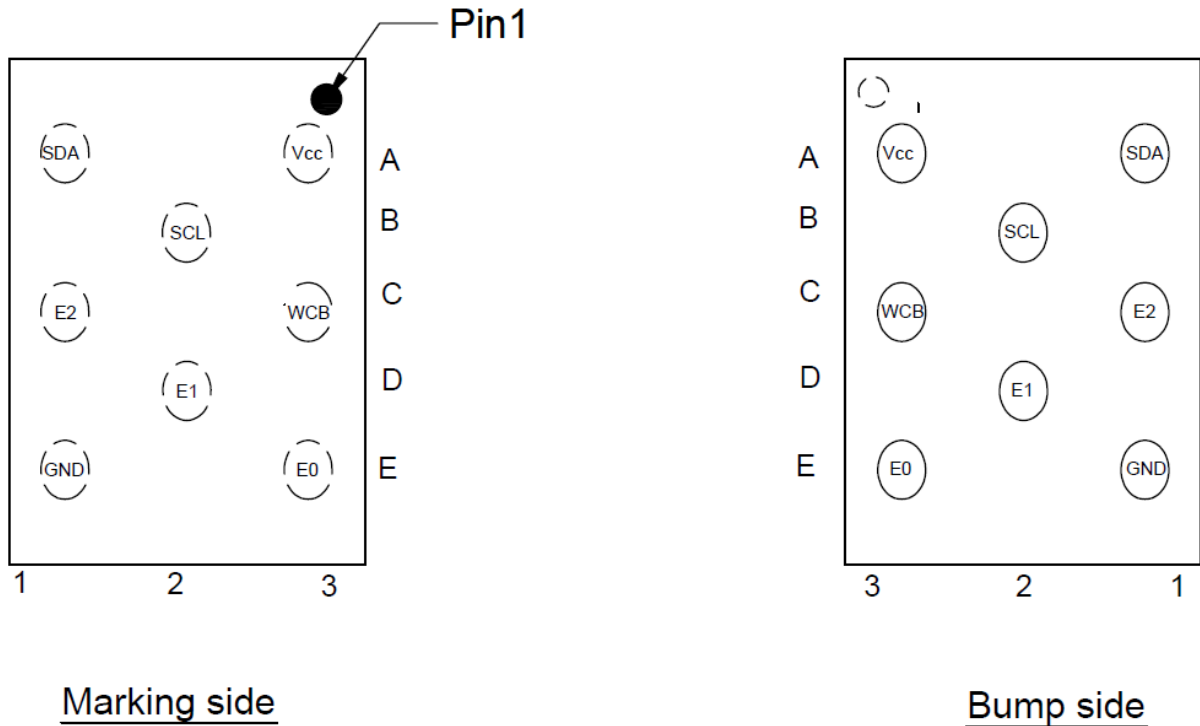

1.2 Pin Definition

Table 1-1 Pin Definition

Pin	Name	Type	Description
E3	E0	I/O	Slave Address Setting
D2	E1	Input	Slave Address Setting
C1	E2	Input	Slave Address Setting
E1	GND	Ground	Ground
A1	SDA	I/O	Serial Data Input and Serial Data Output
B2	SCL	Input	Serial Clock Input
C3	WCB	Input	Write Control, Low Enable Write
A1	Vcc	Power	Power

1.3 Pin Descriptions

Serial Clock (SCL): The SCL input is used to positive-edge clock data in and negative-edge clock data out of each device.

Serial Data (SDA): The SDA pin is bidirectional for serial data transfer. This pin is open drain driven and may be wire-ORed with any number of other open-drain or open-collector devices.

Device Addresses (E2, E1, E0): The E2, E1, and E0 pins are device address inputs. Typically, the E2, E1, and E0 pins are for hardware addressing and a total of 8 devices can be connected on a single bus system. If these pins are left floating, the E2, E1, and E0 pins will be internally pulled down to GND.

Write Control (WCB): The Write Control input, when WCB is connected directly to V_{CC}, all write operations to the memory are inhibited. When connected to GND, allows normal write operations. If the pin is left floating, the WCB pin will be internally pulled down to GND.

2. Block Diagram

Figure 2-1 Block Diagram

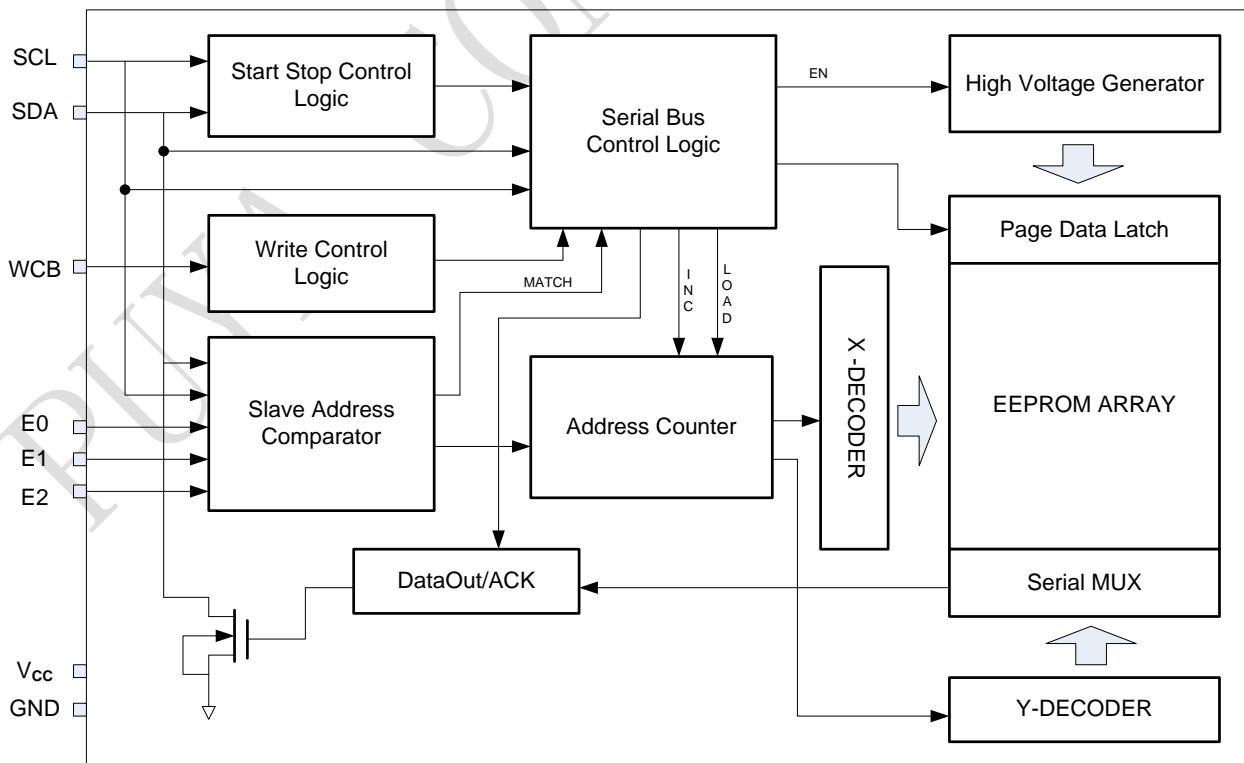

3. Electrical Characteristics

Absolute Maximum Ratings

- Storage Temperature-65°C to +150°C
- Operation Temperature-40°C to +125°C
- Maximum Operation Voltage..... 6.25V
- Voltage on Any Pin with
Respect to Ground.-1.0V to (V_{CC}+1.0)V
- DC Output Current5.0 mA

NOTICE: Stresses above those listed under “Absolute Maximum Ratings” may cause permanent damage to the device. This is a stress rating only and functional operation of the device at those or any other conditions above those indicated in the operational listings of this specification is not implied. Exposure to maximum rating conditions for extended periods may affect device reliability.

Table 3-1 Pin Capacitance ^[1]

Symbol	Parameter	Max.	Units	Test Condition
C _{IO}	Input/Output Capacitance (SDA)	8	pF	V _{IO} =GND
C _{IN}	Input Capacitance (E0,E1,E2,WCB,SCL)	6	pF	V _{IN} =GND

Note: [1] Test Conditions: T_A = 25°C, F = 1MHz, V_{CC} = 5.0V.

Table 3-2 DC Characteristics (Unless otherwise specified, V_{CC} = 1.7V to 5.5V, T_A = -40°C to 125°C)

Symbol	Parameter	Min.	Typ.	Max.	Unit	Test Condition
V _{CC}	Supply Voltage	1.7	-	5.5	V	P24C512B
I _{sb}	Standby Current	-	-	1.0	uA	V _{CC} = 3.3V, T _A = 85°C
		-	-	3.0	uA	V _{CC} = 5.5V, T _A = 85°C
		-	-	6.0	uA	V _{CC} = 5.5V, T _A = 105°C
		-	-	10.0	uA	V _{CC} = 5.5V, T _A = 125°C
I _{CC1}	Supply Current	-	-	0.5	mA	V _{CC} =5.5V, Read at 400Khz
I _{CC2}	Supply Current	-	-	2.5	mA	V _{CC} =5.5V Write at 400Khz
I _{LI}	Input Leakage Current	-	0.10	1.0	μA	V _{IN} = V _{CC} or GND
I _{LO}	Output Leakage Current	-	0.05	1.0	μA	V _{OUT} = V _{CC} or GND
V _{IL}	Input Low Level	-0.6	-	0.3V _{CC}	V	
V _{IH}	Input High Level	0.7V _{CC}	-	V _{CC} +0.5	V	
V _{OL1}	Output Low Level V _{CC} = 1.7V (SDA)	-	-	0.2	V	I _{OL} = 1.5 mA
V _{OL2}	Output Low Level V _{CC} = 3.0V (SDA)	-	-	0.4	V	I _{OL} = 2.1 mA
R _{pd}	Pull-down resistance on WCB	5	130		MΩ	V _{IN} = V _{CC}
		10	30		KΩ	V _{IN} < V _{IL}

Table 3-3 AC Characteristics (Unless otherwise specified, $V_{CC} = 1.7V$ to $5.5V$, $T_A = -40^{\circ}C$ to $125^{\circ}C$, $C_L=100pF$, Test Conditions are listed in Notes [2])

Symbol	Parameter	$1.7 \leq V_{CC} < 1.5$			$2.5 \leq V_{CC} \leq 5.5$			Units
		Min.	Typ.	Max.	Min.	Typ.	Max.	
f_{SCL}	Clock Frequency, SCL	-	-	400	-	-	1000	kHz
t_{LOW}	Clock Pulse Width Low	1.3	-	-	0.4	-	-	μs
t_{HIGH}	Clock Pulse Width High	0.6	-	-	0.4	-	-	μs
t_{AA}	Clock Low to Data Out Valid	0.05	-	0.9	0.05	-	0.55	μs
t_i	Noise Suppression Time	-	-	0.1	-	-	0.05	μs
t_{BUF}	Time the bus must be free before a new transmission can start	1.3	-	-	0.5	-	-	μs
$t_{HD.STA}$	Start Hold Time	0.6	-	-	0.25	-	-	μs
$t_{SU.STA}$	Start Setup Time	0.6	-	-	0.25	-	-	μs
$t_{HD.DAT}$	Data In Hold Time	0	-	-	0	-	-	μs
$t_{SU.DAT}$	Data In Setup Time	0.1	-	-	0.1	-	-	μs
t_R	Inputs Rise Time ^[1]	-	-	0.3	-	-	0.3	μs
t_F	Inputs Fall Time ^[1]	-	-	0.3	-	-	0.1	μs
$t_{SU.STO}$	Stop Setup Time	0.6	-	-	0.25	-	-	μs
t_{DH}	Data Out Hold Time	0.05	-	-	0.05	-	-	μs
$t_{SU.WCB}$	WCB pin Setup Time	1.2	-	-	0.6	-	-	μs
$t_{HD.WCB}$	WCB pin Hold Time	1.2	-	-	0.6	-	-	μs
t_{WR}	Write Cycle Time	-	-	5	-	-	5	ms

Notes: [1] This parameter is ensured by characterization not 100% tested

[2] AC measurement conditions:

- ✧ R_L (connects to V_{CC}): 1.3k (2.5V, 5.5V), 10k (1.7V)
- ✧ Input pulse voltages: $0.3 V_{CC}$ to $0.7 V_{CC}$
- ✧ Input rise and fall times: $\leq 50ns$
- ✧ Input and output timing reference voltages: $0.5V_{CC}$

Table 3-4 Reliability Characteristic ^[1]

Symbol	Parameter	Min.	Typ.	Max.	Unit
EDR ^[2]	Endurance	4,000,000			Write cycles
DRET	Data retention	200			Years

Note: [1] This parameter is ensured by characterization and is not 100% tested

[2] Under the condition: $25^{\circ}C$, 3.3V, Page mode

Figure 3-1 Bus Timing

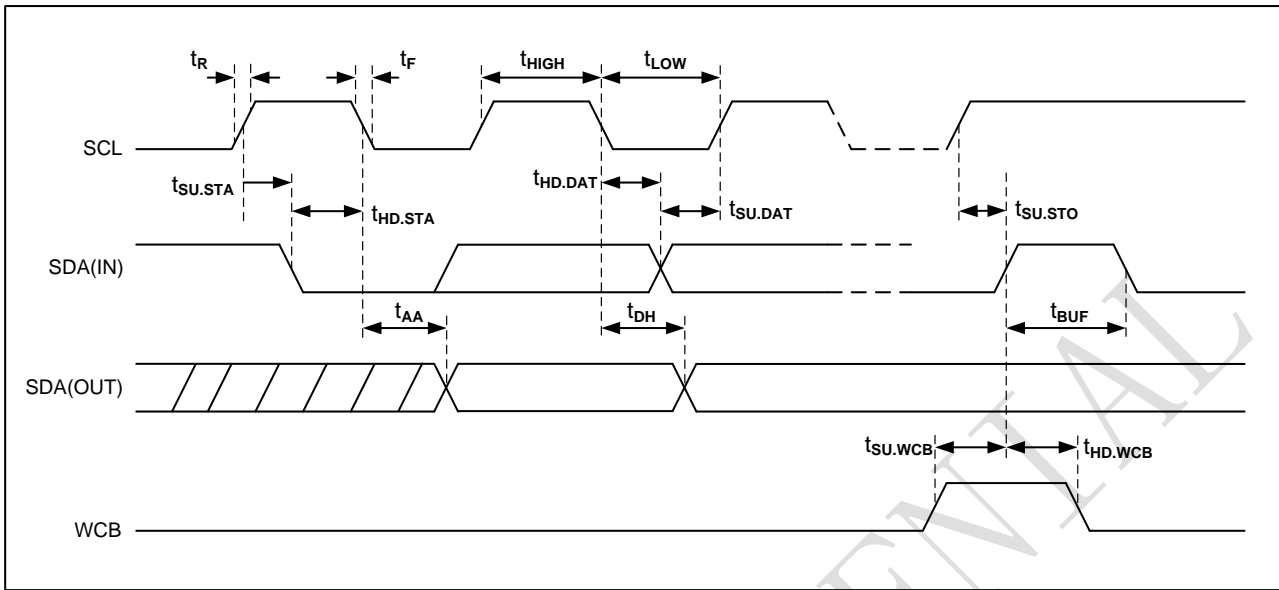
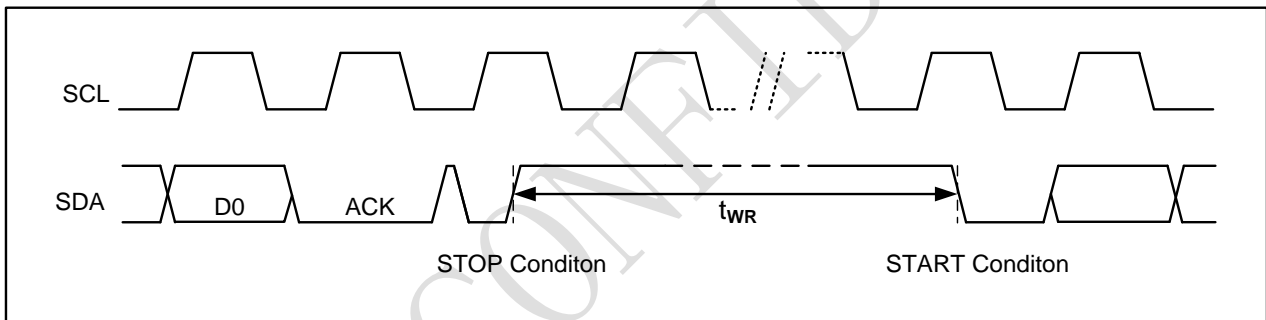

Figure 3-2 Write Cycle Timing



Note: [1] The write cycle time t_{WR} is the time from a valid stop condition of a write sequence to the end of the internal clear/write cycle.

PUYA

4. Device Operation

4.1 Data Input

The SDA pin is normally pulled high with an external device. Data on the SDA pin may change only during SCL low time periods (see to Figure 4-1). Data changes during SCL high periods will indicate a start or stop condition as defined below.

Figure 4-1 Data Validity

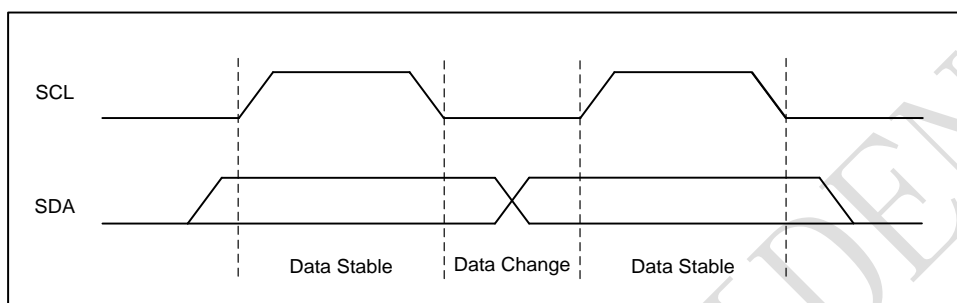

4.2 Start Condition

A high-to-low transition of SDA with SCL high is a start condition which must precede any other command (see to Figure 4-2).

4.3 Stop Condition

A low-to-high transition of SDA with SCL high is a stop condition. After a read sequence, the stop command will place the P24C512B in a standby power mode (see Figure 4-2).

Figure 4-2 Start and Stop Definition

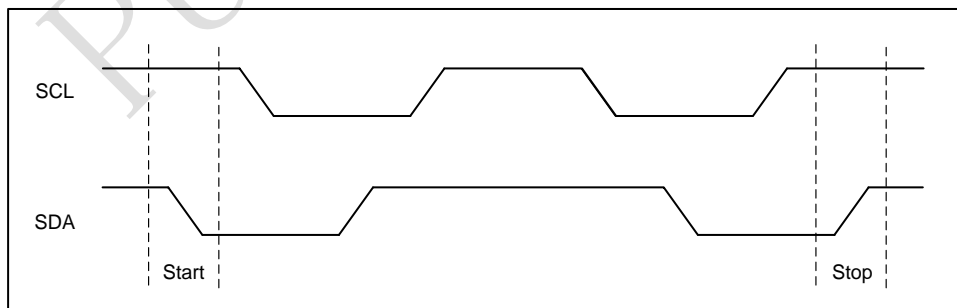

4.4 Acknowledge (ACK)

All addresses and data words are serially transmitted to and from the P24C512B in 8-bit words. The P24C512B sends a “0” to acknowledge that it has received each word. This happens during the ninth clock cycle.

Figure 4-3 Output Acknowledge

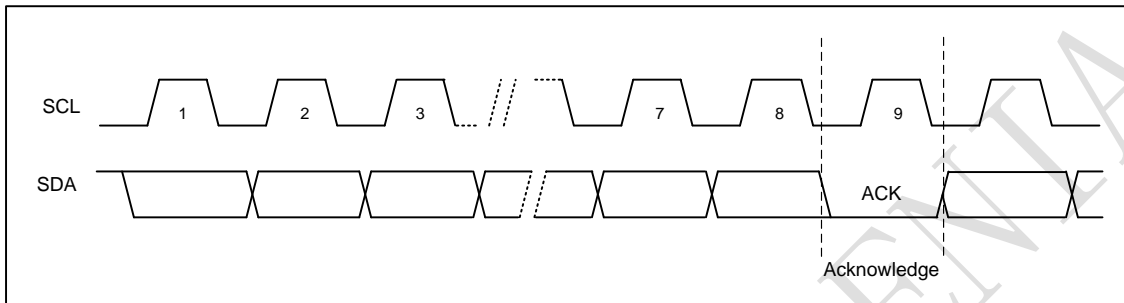

4.5 Standby Mode

The P24C512B features a low-power standby mode which is enabled: (a) after a fresh power up, (b) after receiving a STOP bit in read mode, and (c) after completing a self-time internal programming operation

4.6 Soft Reset

After an interruption in protocol, power loss or system reset, any two-wire part can be reset by following these steps: (a) Create a start condition, (b) Clock nine cycles, and (c) create another start bit followed by stop bit condition, as shown below. The device is ready for the next communication after the above steps have been completed.

Figure 4-4 Soft Reset

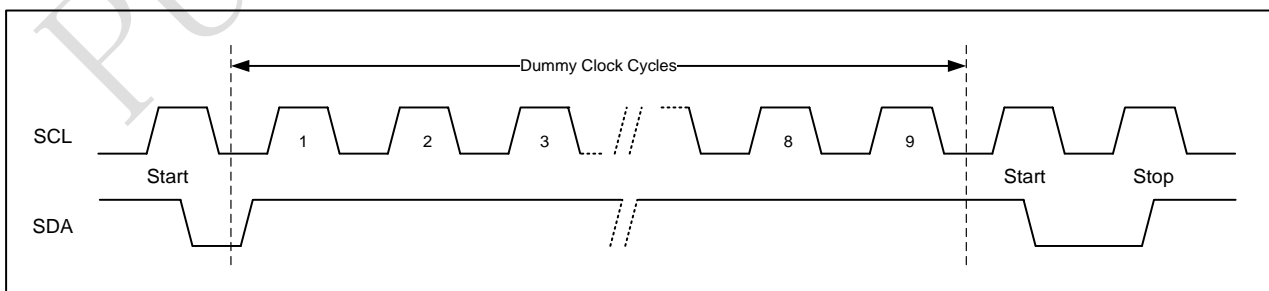

4.7 Device Addressing

The P24C512B requires an 8-bit device address word following a start condition to enable the chip for a read or write operation (see Figure4-5). The device address word consists of a mandatory one-zero sequence for the first four most-significant bits, as shown.

Figure 4-5 Device Address

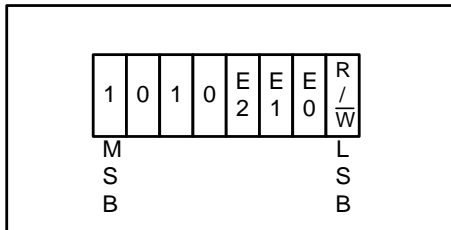

The three E2, E1, and E0 device address bits allow as many as eight devices on the same bus. These bits must compare to their corresponding hardwired input pins.

The E2, E1, and E0 pins use an internal proprietary circuit that biases them to a logic low condition if the pins are floating.

The eighth bit of the device address is the read/write operation select bit. A read operation is initiated if this bit is high and a write operation is initiated if this bit is low. Upon a compare of the device address, the Chip will output a zero. If a compare is not made, the device will return to a standby state.

4.8 Data Security

P24C512B has a hardware data protection scheme that allows the user to write protect the whole memory when the WCB pin is at Vcc.

5. Instructions

5.1 Write Operations

5.1.1 BYTE WRITE

A write operation requires two 8-bit data word address (A15/A0) following the device address word and acknowledgment. Upon receipt of this address, the P24C512B will again respond with a “0” and then clock in the first 8-bit data word. Following receipt of the 8-bit data word, the P24C512B will output a “0” and the addressing device, such as a microcontroller, must terminate the write sequence with a stop condition. And then the P24C512B enters an internally timed write cycle, all inputs are disabled during this write cycle and the P24C512B will not respond until the write is complete (see Figure 5-1).

Figure 5-1 Byte Write

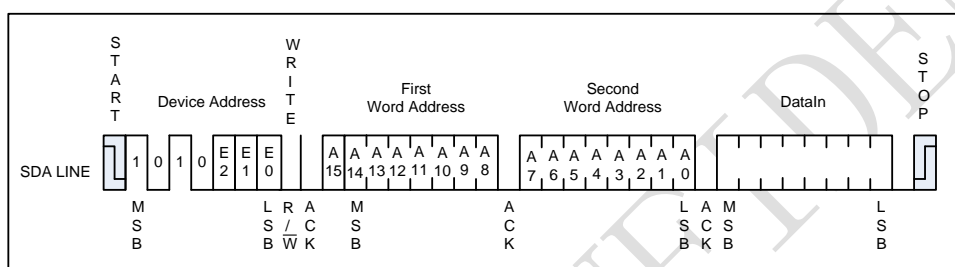

Notes: [1] x means don't care.

5.1.2 Page Write

A page write is initiated the same as a byte write, but the master does not send a stop condition after the first data word is clocked in. Instead, after the P24C512B acknowledges receipt of the first data word, the master can transmit more data words. The P24C512B will respond with a “0” after each data word received. The microcontroller must terminate the page write sequence with a stop condition.

Figure 5-2 Page Write

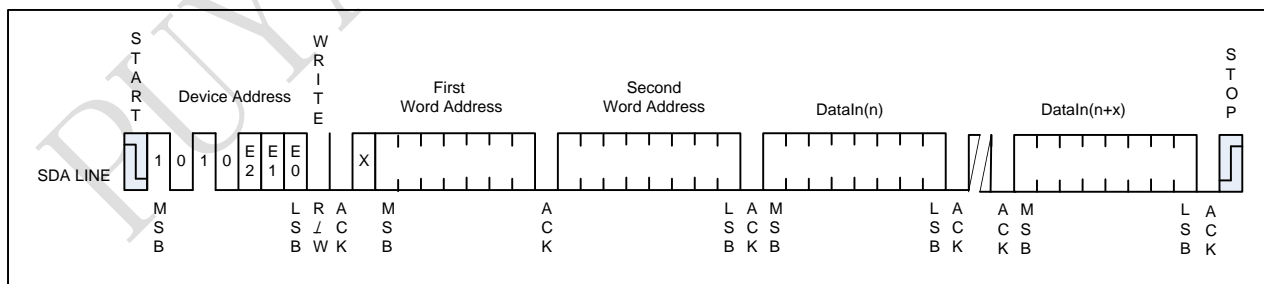

The lower seven bits of the data word address are internally incremented following the receipt of each data word. The higher data word address bits are not incremented, retaining the memory page row location. When the word address, internally generated, reaches the page boundary, the following byte is placed at the beginning of the same page. If more than 128 data words are transmitted to the P24C512B, the data word address will roll-over, and previous data will be overwritten. The address roll-over during write is from the last byte of the current page to the first byte of the same page.

5.1.3 Acknowledge Polling

Once the internally timed write cycle has started and the P24C512B inputs are disabled, acknowledge polling can be initiated. This involves sending a start condition followed by the device address word. The read/write bit is representative of the operation desired. Only if the internal write cycle has completed will the P24C512B respond with a “0”, allowing the read or write sequence to continue.

5.1.4 Write Identification Page

The Identification Page (128 bytes) is an additional page which can be written and (later) permanently locked in Read-only mode. It is written by the Write Identification Page instruction. This instruction uses the same protocol and format as Page Write (into memory array), except for the following differences:

- Device type identifier = 1011b
- MSB address bits A15/A7 are don't care except for address bit A10 which must be '0'.
LSB address bits A6/A0 define the byte address inside the Identification page. If the Identification page is locked, the data bytes transferred during the Write Identification Page instruction are not acknowledged (NoACK).

5.1.5 Lock Identification Page

The Lock Identification Page instruction (Lock ID) permanently locks the Identification page in Read-only mode. The Lock ID instruction is similar to Byte Write (into memory array) with the following specific conditions:

- Device type identifier = 1011b
- Address bit A10 must be '1'; all other address bits are don't care
- The data byte must be equal to the binary value xxxx xx1x, where x is don't care

5.2 Read Operations

Read operations are initiated the same way as write operations with the exception that the read/write select bit in the device address word is set to “1”. There are three read operations: Current Address Read; Random Address Read and Sequential Read.

5.2.1 Current Address Read

The internal data word address counter maintains the last address accessed during the last read or write operation, incremented by one. This address stays valid between operations as long as the chip power is maintained. The address roll-over during read is from the last byte of the last memory page to the first byte of the first page.

Once the device address with the read/write select bit set to “1” is clocked in and acknowledged by the P24C512B, the current address data word is serially clocked out. The microcontroller does not respond with an input “0” but does generate a following stop condition (see Figure 5-3).

Figure 5-3 Current Address Read

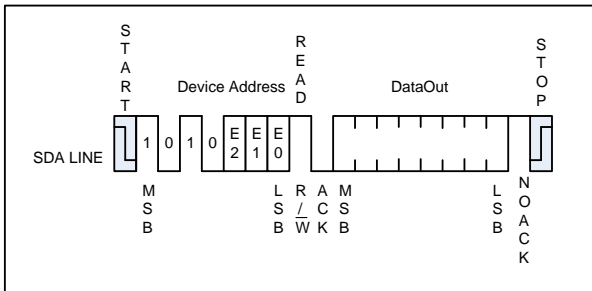

5.2.2 Random Read

A Random Read requires a “dummy” byte write sequence to load in the data word address. Once the device address word and data word address are clocked in and acknowledged by the P24C512B, the microcontroller must generate another start condition. The microcontroller now initiates a Current Address Read by sending a device address with the read/write select bit high. The P24C512B acknowledges the device address and serially clocks out the data word. The microcontroller does not respond with a “0” but does generate a following stop condition (see Figure 5-4).

Figure 5-4 Random Read

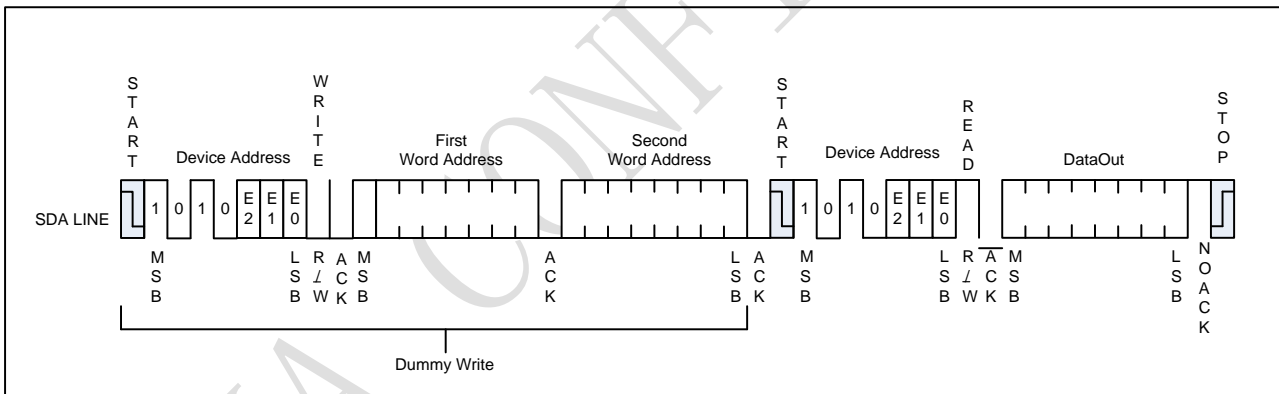

5.2.3 Sequential Read

Sequential Reads are initiated by either a Current Address Read or a Random Address Read. After the microcontroller receives a data word, it responds with acknowledge. As long as the P24C512B receives acknowledge, it will continue to increment the data word address and serially clock out sequential data words. When the memory address limit is reached, the data word address will roll-over and the Sequential Read will continue. The Sequential Read operation is terminated when the microcontroller does not respond with a “0” but does generate a following stop condition (see Figure 5-5)

Figure 5-5 Sequential Read

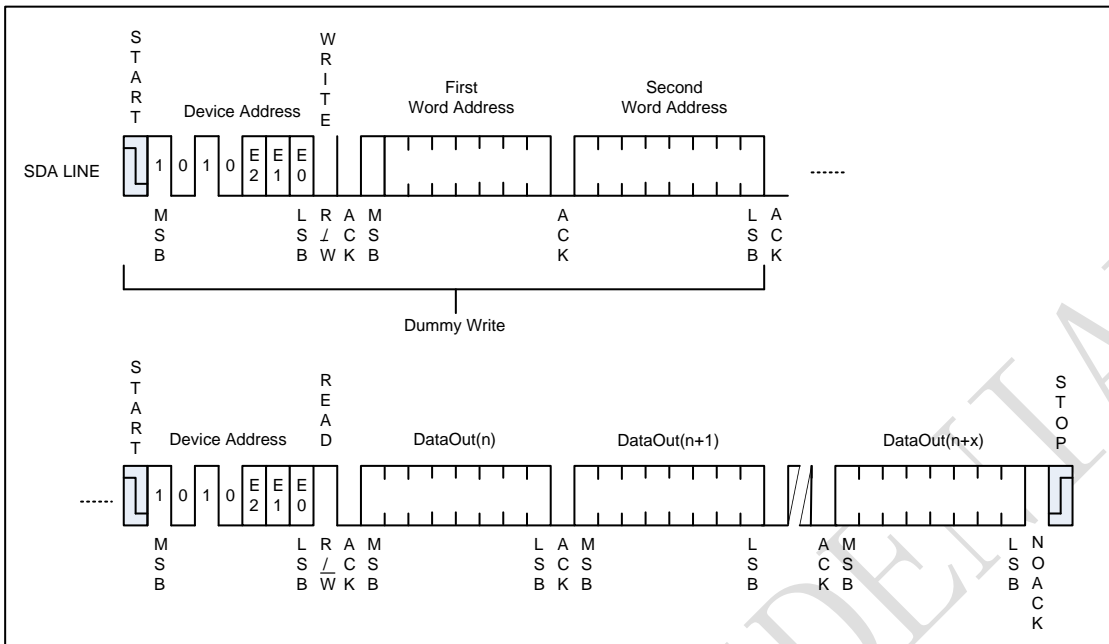

5.2.4 Read Identification Page

The Identification Page (128 bytes) is an additional page which can be written and (later) permanently locked in Read-only mode. The Identification Page can be read by Read Identification Page instruction which uses the same protocol and format as the Read Command (from memory array) with device type identifier defined as 1011b. The MSB address bits A15/A7 are don't care, the LSB address bits A6/A0 define the byte address inside the Identification Page. The number of bytes to read in the ID page must not exceed the page boundary (e.g. when reading the Identification Page from location 10d, the number of bytes should be less than or equal to 118, as the ID page boundary is 128 bytes).

5.2.5 Read Lock Status

The locked/unlocked status of the Identification page can be checked by transmitting a specific truncated command [Identification Page Write instruction + one data byte] to the device. The device returns an acknowledge bit if the Identification page is unlocked, otherwise a NoACK bit if the Identification page is locked.

Figure 5-6 Lock Status Read (When Identification page locked, return NoACK after one data byte)

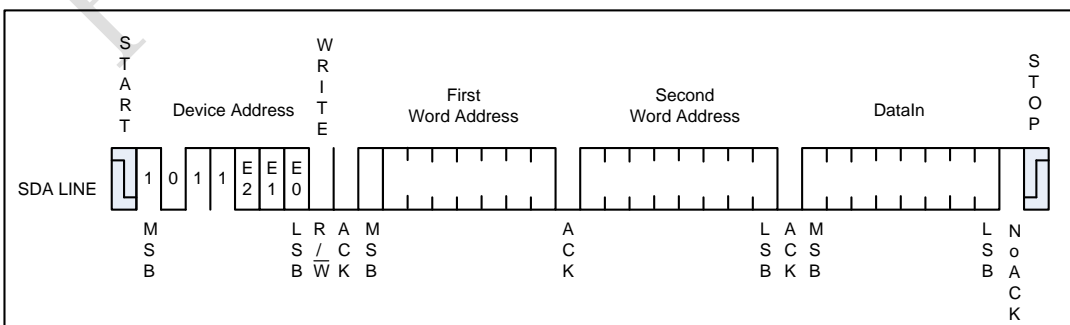

6. Ordering Code Detail

Example:

P 2 4 C 512 B - D 8 H - M I R

Company Designator

P = Puya Semiconductor

Product Series Name

24C = I2C-compatible Interface EEPROM

Device Densitv

512 =512k bit

Device Reversion

B = Version B

Package Option

D8: 8 Ball WLCSP

Plating Technology

H: RoHS Compliant, Halogen-free, Antimony-free

Operation Voltage

M: 1.7~5.5V

Device Grade

I: -40~85C

K: -40~105C

Shipping Carrier Option

R :TAPE & REEL

7. Package Information

7.1 8 Ball WLCSP

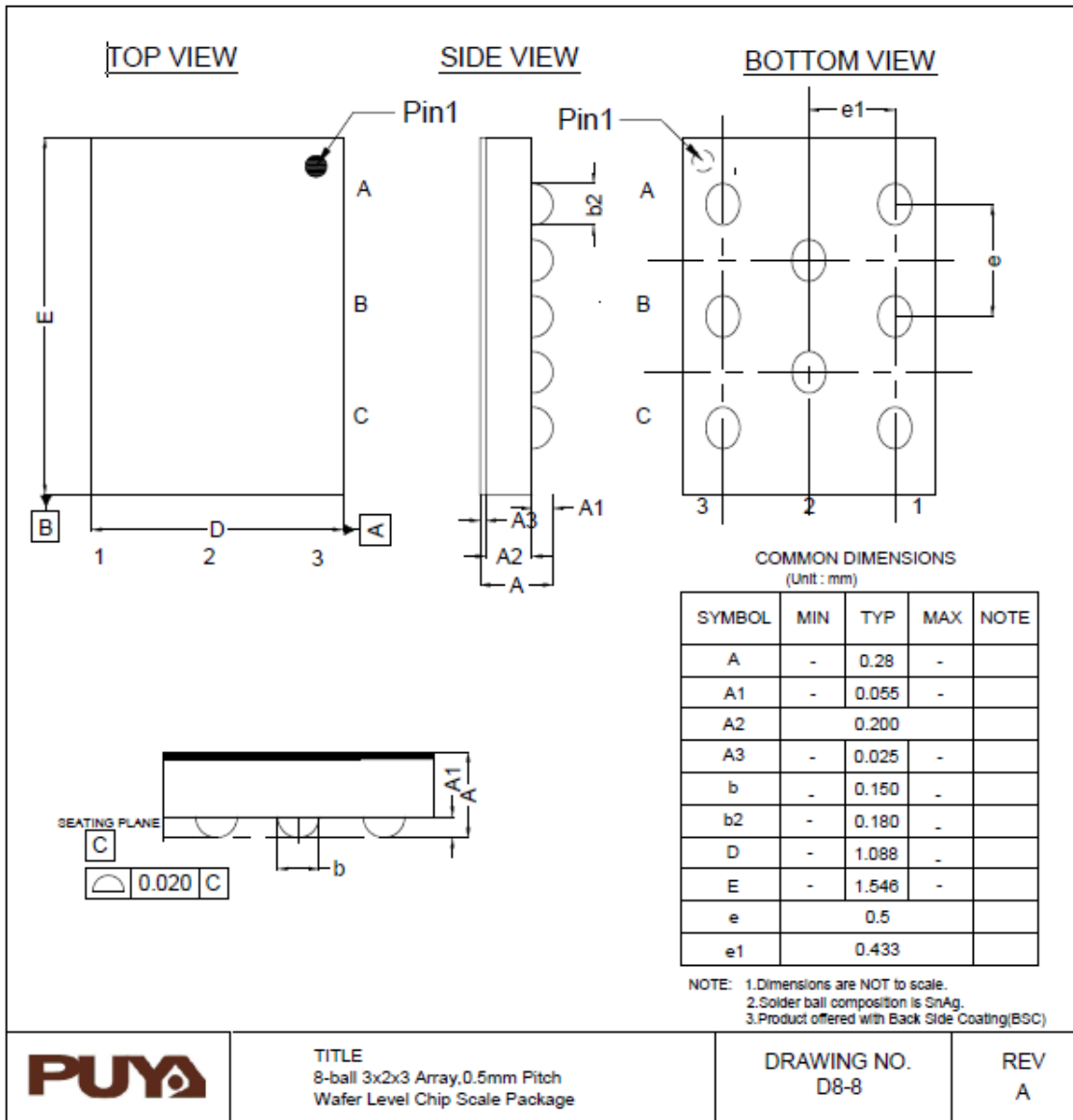

<Tape and Reel information>

Tape	Embossed carrier tape
Quantity	3000pcs
Direction of feed	The direction is the 1pin of product is at the upper left when you hold reel on the left hand and you pull out the tape on the right hand

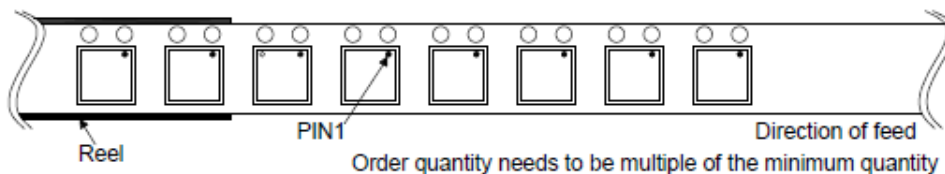

8. Revision History

Version	Content	Date
Rev1.0	Initial Release	2018-10-8



Puya Semiconductor Co., Ltd.

IMPORTANT NOTICE

Puya Semiconductor reserves the right to make changes without further notice to any products or specifications herein. Puya Semiconductor does not assume any responsibility for use of any its products for any particular purpose, nor does Puya Semiconductor assume any liability arising out of the application or use of any its products or circuits. Puya Semiconductor does not convey any license under its patent rights or other rights nor the rights of others.